

How to Measure Curved Tufted Cushion

Measurement Instruction

- ✓ Give exact measurement from edge to edge.
- ✓ The height dimensions will remain same as provided by you.
- ✓ Size may vary from 0 to ±5 cm from the given width/depth for a better fit.

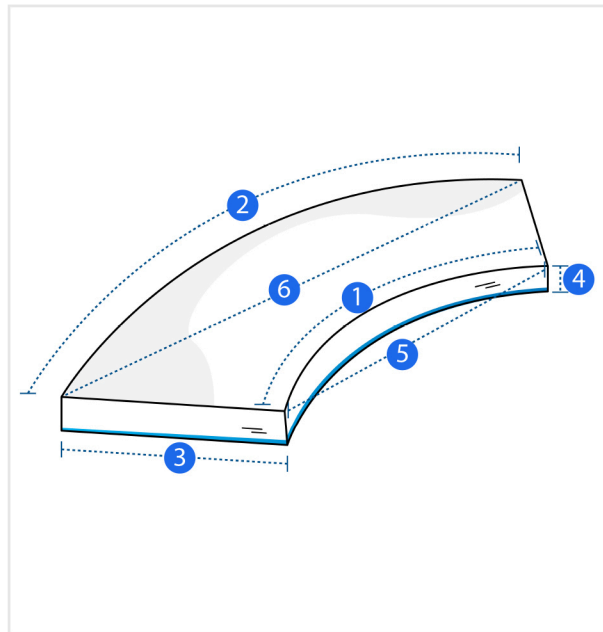

Measurement (cm)

1. Front Arc Length	<input type="text"/>	2. Back Arc Length	<input type="text"/>
3. Depth	<input type="text"/>	4. Thickness	<input type="text"/>
5. Front Width	<input type="text"/>	6. Back Width	<input type="text"/>

1. Front Arc Length:
Front Arc Length of the Curved Cushion

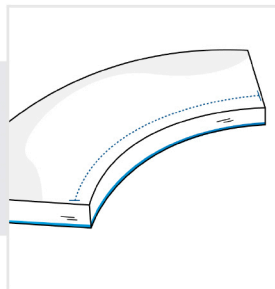

2. Back Arc Length:
Back Arc Length of the Curved Cushion

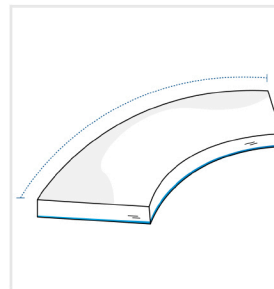

3. Depth:
Depth of the Curved Cushion

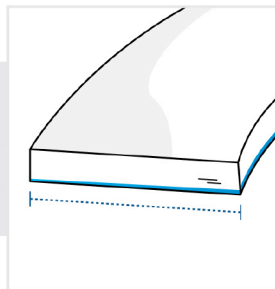

4. Thickness:
Thickness of the Curved Cushion

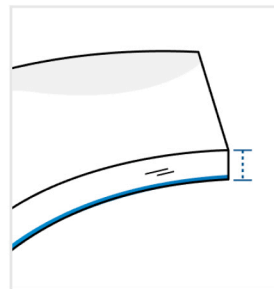

5. Front Width:
Front Width of the Curved Cushion

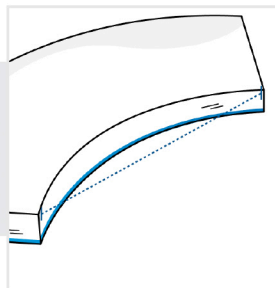

6. Back Width:
Back Width of the Curved Cushion

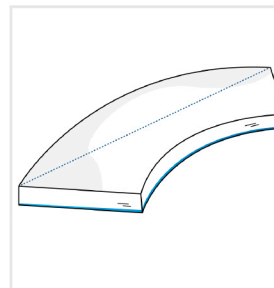

We encourage you to upload the image of the article you need the cover for - this helps our team ensure covers are designed keeping your requirements in mind.